



Mass Spectrometers for Residual Gas Analysis Applications (RGA)

MASS SPECTROMETERS

for Residual Gas Analysis Applications (RGA)

Residual gas analysers (RGA) provide a unique window into the vacuum environment for contamination monitoring, leak detection and analysis of the species of interest within the vacuum chamber, water vapour for example. The Hiden residual gas analysers are quadrupole mass spectrometers configured in a broad range of products to address applications in vacuum processing, science and technology.

Hiden residual gas analysers are equipped with software that is intuitive and multi-level offering simple fail-safe* operation for a novice user whilst incorporating a broad range of useful and advanced features for the vacuum expert.

THE VACUUM RESIDUALS ROUTINELY ANALYSED INCLUDE:

Hydrogen, measured at mass 2, and of specific interest in UHV where outgassing can be the limiting factor for achieving ultimate vacuum.

Helium, measured at mass 4, and used as a search gas for leak detection. Hiden residual gas analysers include a dedicated leak detect mode, for fast response analysis of helium.

Water Vapour, measured at mass 18, is the most difficult residual to pump to UHV level without baking or pumping the vacuum chamber for extended periods.

Nitrogen and Oxygen, measured at mass numbers 28 and 32, with additional peaks measured for confirmation at mass numbers 14 and 16. The measurement of significant signal for the 'air peaks' is often the first indication of a chamber leak.

Hydrocarbons are analysed at several masses across a mass scan and typically can be identified at mass numbers 69 and 71, 55 and 57, 41 and 43, and 15 for alkanes and alkenes. The residual gas analyser broad mass scan with high sensitivity allows the user to get detailed information regarding the contamination level of the chamber.

Volatile Organic Compounds, measured at species specific masses including mass 78 for benzene, 91 for toluene, 31 for ethanol, and 45 for isopropyl alcohol.

Hiden's residual gas analysers analyse the above species with a real-time data display to give the vacuum user immediate and updated information about the health and trends of the partial pressure of the key vacuum residuals. Data is used for routine vacuum chamber monitoring, leak detection, for analysis of vacuum processes, and for advanced research studies.

WHAT OUR CUSTOMERS SAY:

"... I strongly feel (based on experience) that, products supplied by Hiden can be fully relied upon for their quality and reliability and equally well for the support from the Hiden family, right from the point of planning to the point of implementation."



*On board safety features include overpressure protection for both filament and detector by internal measurement as well as connection for an external overpressure protection device.

Contents

RGA SERIES - Introduction

HALO - for Residual Gas Analysis

HAL/3F - Triple Filter Mass Spectrometer for Analytical Applications

HAL/3F PIC - Triple Filter Mass Spectrometer with Pulse Ion Counting Detection for Fast Event Studies

RGA ANALYSER DIMENSIONS

ION SOURCE OPTIONS

HMT - High Pressure Residual Gas Analyser

HAL 201 RC - for Demanding UHV Applications

qRGA - for Fusion Research

HALO 201 MBE - for Molecular Beam Epitaxy Applications

XBS - Deposition Rate Monitor for Molecular Beam Analysis & Deposition Control

3F PIC - for UHV TPD

EPIC & IDP - for UHV Analysis of Neutrals, Radicals & Ions

3F SERIES 1000 - for High Precision Scientific & Process Applications

RGA CONTROL SOFTWARE - MASsoft, *netMASsoft*, Advanced Software Features



HAL/3F PIC

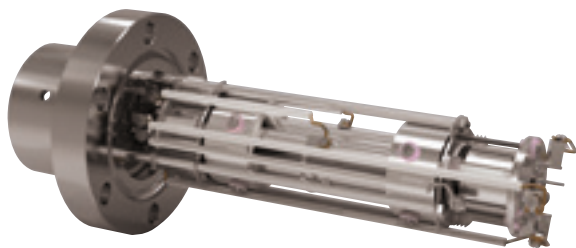

HMT



Gold plated ion source.

RGASERIES

All Hiden residual gas analysers are application tested and calibrated to provide the highest quality performance, and they are backed by a 3 year warranty and lifetime service support.

- ▶ vacuum diagnostics
- ▶ reactive sputtering closed loop control
- ▶ leak detection
- ▶ vacuum furnace monitoring
- ▶ contamination analysis
- ▶ molecular beam studies
- ▶ semiconductor production
- ▶ UHV/XHV surface science
- ▶ vacuum process analysis
- ▶ UHV TPD

THE HIDEN RGA SERIES INCLUDES THREE SPECIFICATION LEVELS:

HALO - for residual gas analysis.

HAL/3F - triple filter mass spectrometers for analytical applications.

HAL/3F PIC - pulse ion counting detection for fast event studies.



HALO 100 RC

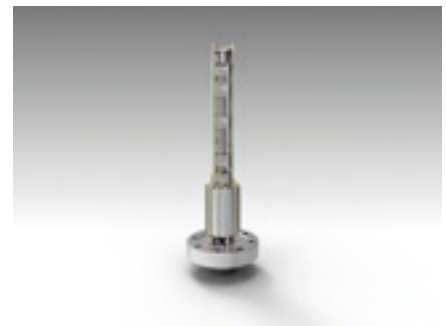

HAL/3F



HAL/3F PIC

CORE FEATURES/OPTIONS:

- ▶ mass range options: 50, 100, 200, 300, 510 amu
- ▶ ultra fast data acquisition - up to 650 measurements per second
- ▶ twin burnout-resistant oxide coated iridium filaments
- ▶ real-time background subtract
- ▶ embedded web server with *netMAS*soft Java applet - enables simplified RGA operation from a web browser
- ▶ range of ion source and shroud options
- ▶ integral mass library
- ▶ advanced analysis capability for complex gas interpretation
- ▶ high sensitivity helium leak detection, mass selectable for alternative search gases

HALO

for Residual Gas Analysis



HALO 201 RC

- ▶ vacuum fingerprint: histogram & peak profile scan
- ▶ trend analysis: monitor multiple species > 80 partial pressure values in real-time
- ▶ leak detection
- ▶ zero blast baseline drift is eliminated: compare and analyse vacuum chamber residual gas/vapour species

Detector options:

- Faraday-only, Faraday/Electron Multiplier

Sensitivity with:

- Faraday - detection to 1×10^{-11} mbar
- Electron Multiplier - detection to 2×10^{-13} mbar

Maximum Operating Pressure:

- 1×10^{-4} mbar

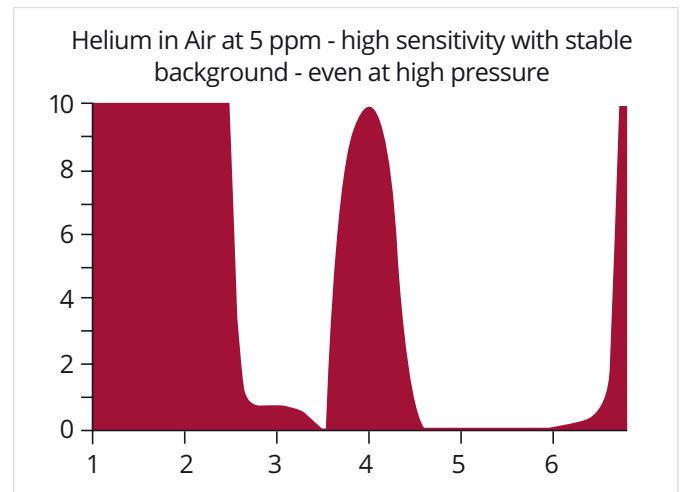

Hidden's RGA sensitivity for helium is 5 times* that of a typical analyser providing excellent leak detection performance.

FEATURES:

- ▶ mass range options: 100, 200 and 300 amu
- ▶ detector options: Faraday or Faraday and Electron Multiplier
- ▶ PC Windows controlled
- ▶ **Automated Electronic Beam Shutter EBS™** optimises noise suppression
- ▶ **Automatic DeSat™ mode** for high speed scanning even in the presence of saturating signals

*Based on reference to published relative sensitivity data.

HAL/3F

Triple Filter Mass Spectrometer for Analytical Applications

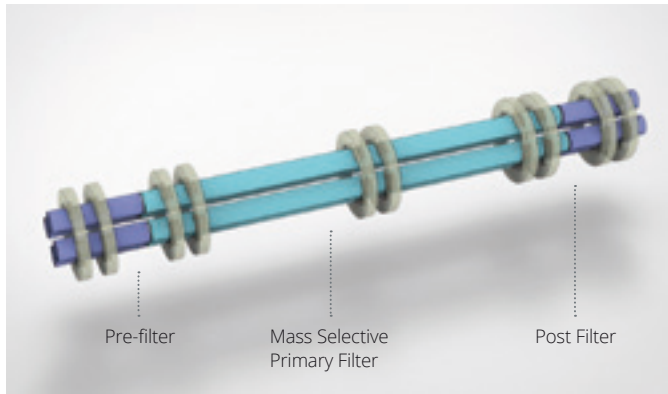

Triple Filter Assembly.

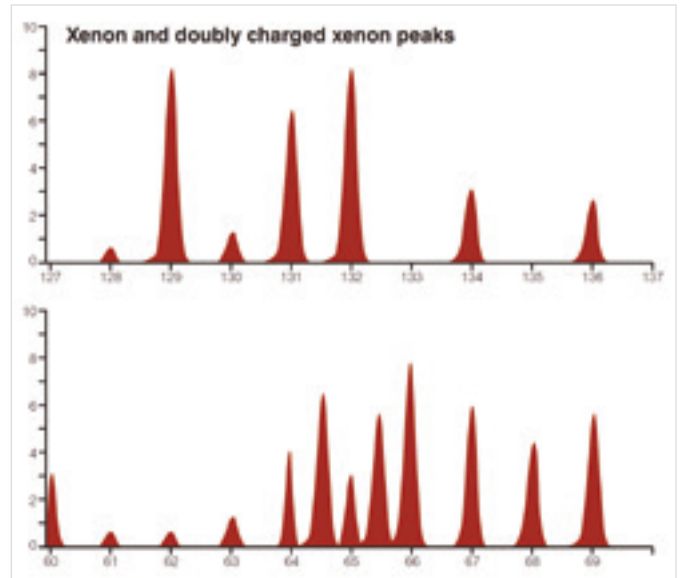

3F Performance includes enhanced sensitivity for high mass species and increased resolution capabilities

- ▶ triple mass filter technology for high sensitivity with enhanced contamination resistance and abundance sensitivity
- ▶ application-specific ionisation sources for gas analysis, molecular beam measurement and UHV/XHV studies

Mass range options:

- 50, 200, 300 and 510 amu
- Series 1000 for mass range options up to 1000 amu
- Sensitivity with Faraday and Single Channel Electron Multiplier Detectors – 2×10^{-14} mbar

Maximum operation pressure:

- 1×10^{-4} mbar

FEATURES:

- ▶ mass range options: 50, 200, 300 and 510 amu
- ▶ detector: Faraday and Single Channel Electron Multiplier
- ▶ full control of field axis potential: ion source emission, electron energy, ion energy
- ▶ **Automated Electronic Beam Shutter EBS™** optimises noise suppression
- ▶ **Automatic DeSat™ mode** for high speed scanning even in the presence of saturating signals

HAL/3F PIC

Triple Filter Mass Spectrometer with Pulse Ion Counting Detection for Fast Event Studies

- ▶ Pulse ion counting detection for fast event studies including UHV TPD and for transient gas analysis
- ▶ 7 decade continuous measurement from 1 c/s to 10^7 c/s
- ▶ Multi-channel scaler detector option with time resolution to 50 nanoseconds

Mass range options:

- 50, 300 and 510 amu
- Series 1000 for mass range options up to 1000 amu
- Sensitivity with pulse ion counting detector $< 5 \times 10^{-15}$ mbar

Maximum operation pressure:

- 5×10^{-6} mbar
- 1×10^{-4} mbar with Faraday option

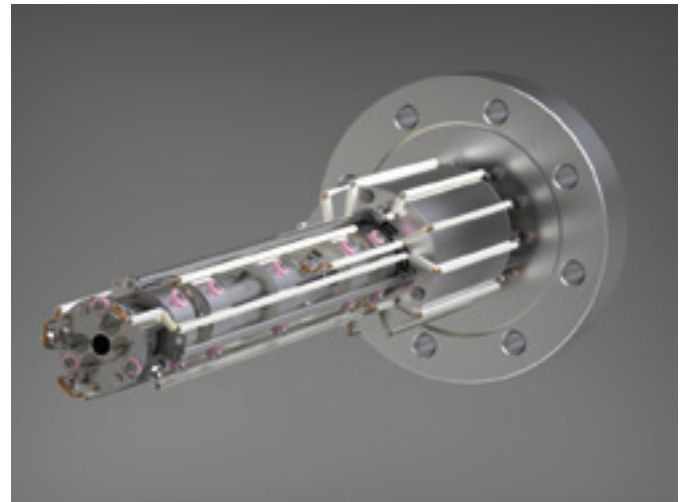

HAL/3F PIC

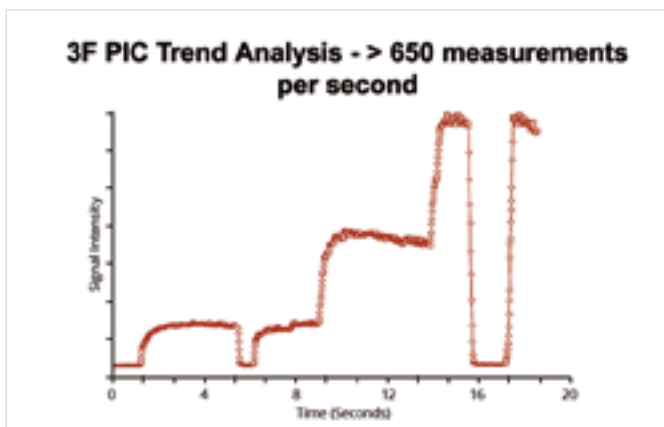

High quality transient data acquisition at PPM/PPB levels. Ideal for UHV TPD.

FEATURES:

- ▶ 7 decade dynamic range
- ▶ > 650 measurements per second
- ▶ detection to $< 5 \times 10^{-15}$ mbar
- ▶ signal gating for pulsed studies
- ▶ multi-channel scaler option with 50 nanoseconds time resolution
- ▶ PCA mode - Predictive count accumulation mode. Significantly extends electron multiplier life.

RGA ANALYSER DIMENSIONS

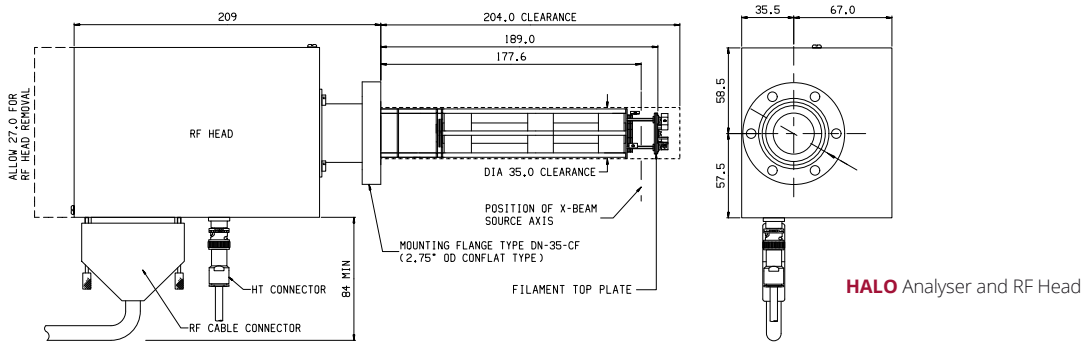

HALO Analyser and RF Head

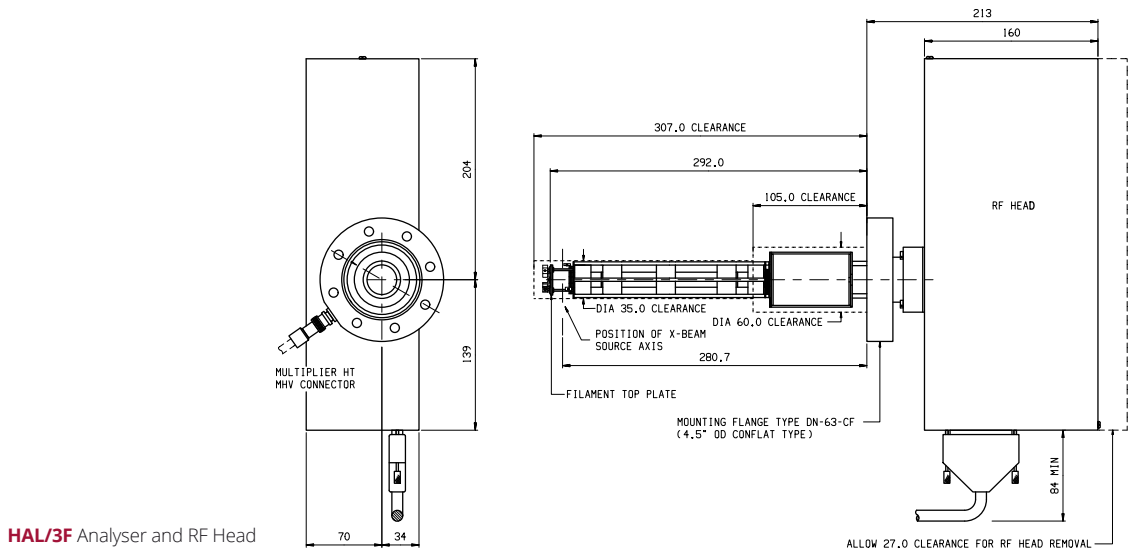

HAL/3F Analyser and RF Head

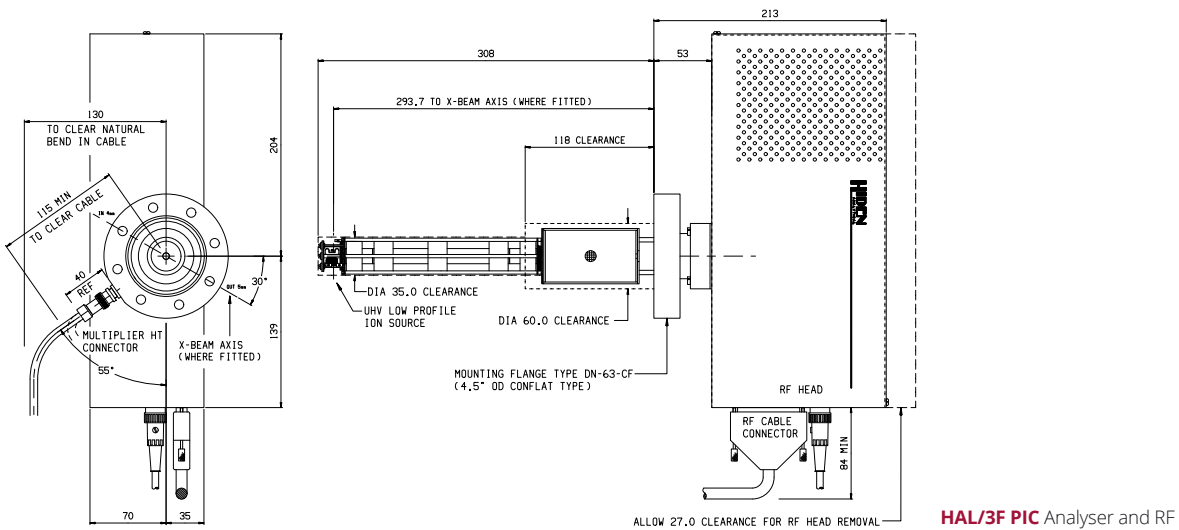

HAL/3F PIC Analyser and RF

ION SOURCE OPTIONS



Standard and UHV low profile sources.



Standard and UHV low profile gold sources.

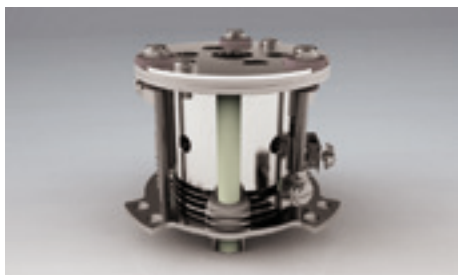

Laser cross beam source.

Hidden Analytical produces a wide variety of ion source types which can be fitted to our full range of RGAs. Ion source types are crucial to the performance of RGAs and having the ability to specify which source you require ensures our RGAs are custom configured for specific applications.

ION SOURCE OPTIONS

Standard RGA - A radially symmetric configuration for general applications.

UHV Low Profile - Optimised for UHV TPD studies enabling closer proximity of the ion source to the evolution surface.

Closed Sources - For high pressure studies with direct gas input used in conjunction with a differential pumping stage for the analyser.

XBS Cross Beam - The XBS Cross Beam is configured specifically for MBE deposition rate monitoring and control.

Basic Cross Beam - The Basic Cross Beam source is used for analysis of molecular beams, where the beam may be liable to condense on ioniser surfaces. The source features an unobstructed pathway through the ionising region of the source. External shrouds are available to protect the quadrupole mass filter from condensing species.

Laser Cross Beam Source - The Laser Cross Beam source includes two orthogonal unobstructed pathways for laser photon ionisation within the source cage region, providing an alternative to electron impact and electron attachment ionisation.

4 Lens Ion Optics with Integral Ioniser - Additionally enables analysis of low energy positive and negative ions generated externally to the analyser. For electron, photon and laser stimulated desorption studies.

Platinum Ion Source - This source is configured for improved operation in reactive gases. Radially symmetric, UHV compatible.

Gold Plated Ion Source - This source is configured to minimise the effects of source outgassing. Radially symmetric, UHV compatible. Available as Standard or Low Profile options.

FEATURES:

- ▶ standard filament material is oxide coated iridium
- ▶ other materials available on request
- ▶ ion source options are interchangeable
- ▶ open and closed sources available
- ▶ range of cross beam sources available
- ▶ standard and low profile options available

HMT

High Pressure Residual Gas Analyser

The Hiden HMT quadrupole mass spectrometer is a unique dual mode RGA system capable of operating at pressures up to 5×10^{-3} mbar without the need for differential pumping. Operation at this pressure is achieved using a specially designed ion source/quadrupole filter combination and software which corrects for abundance non-linearity. The unique high pressure specification makes the HMT ideal for process monitoring applications.

The HMT can also operate in RGA mode in the same way as a traditional quadrupole RGA. Dual Faraday and electron multiplier detectors provide partial pressure sensitivities down to the 10^{-13} mbar range.

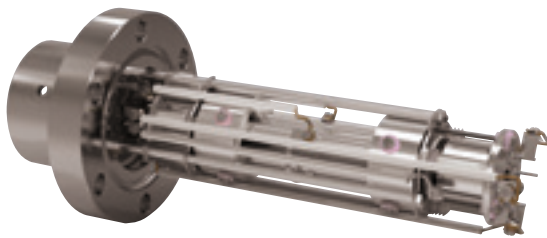

HMT

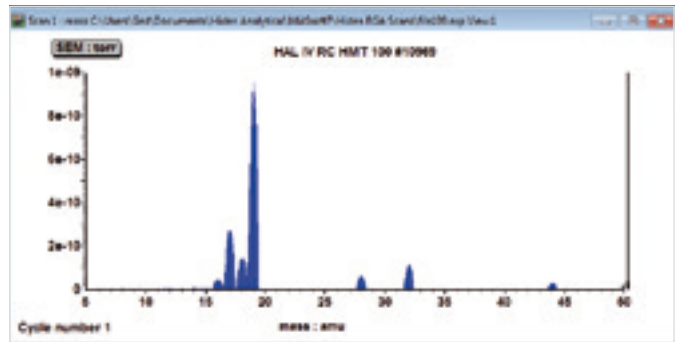

Profile mass scanning in RGA high sensitivity mode.

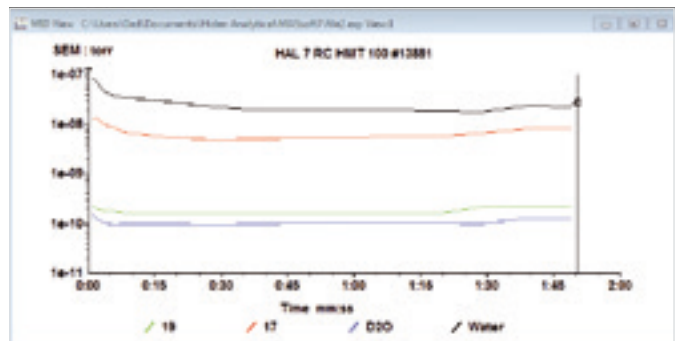

Multi-component trend analysis.

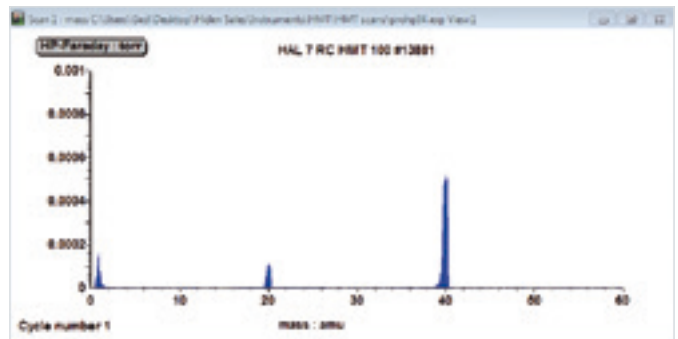

Profile mass scanning in high pressure HMT mode.

FEATURES:

- ▶ HMT mode for high pressure operation to 5×10^{-3} mbar
- ▶ RGA mode for high sensitivity operation to 10^{-13} mbar
- ▶ 100 amu mass range
- ▶ stability better than +/- 1% over 24 hours
- ▶ fast access mixed mode scanning
- ▶ real-time background subtraction

HAL 201 RC

for Demanding UHV Applications

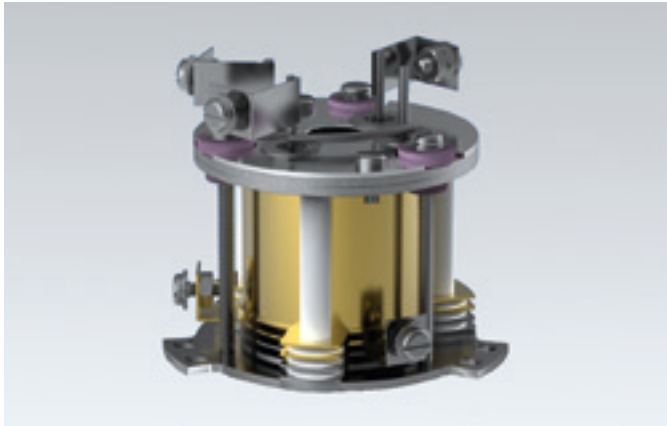

Gold plated ion source.

Radiation Resistant as standard. Radiation Hard option available.



Remote RF and 15m cable. Radiation 'Hard' version.

The Hiden RGA for UHV are designed and configured for residual gas analysis in demanding UHV applications where critical measurements at UHV are required.

The HAL analyser includes, as standard, gold plated versions of all ion source types. The gold plated ion source is provided to minimise source outgassing, suited for applications where total pressure is $< 5 \times 10^{-10}$ mbar.

EPICS is the standard instrument control software used in many light sources around the world and the Hiden HAL system is fully compatible with EPICS software drivers.

- ▶ beam lines
- ▶ Tokamaks/Torus facilities
- ▶ particle accelerators
- ▶ synchrotrons
- ▶ UHV chambers

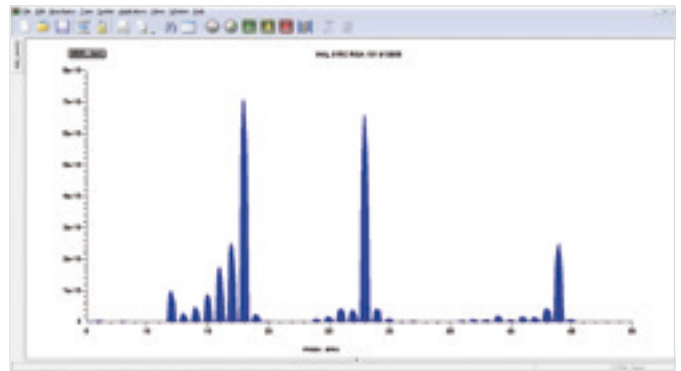

Typical profile spectrum for HAL system.

FEATURES/OPTIONS:

- ▶ gold plated ion sources to minimise source outgassing
- ▶ electron impact ioniser with twin oxide coated iridium filament
- ▶ dual Faraday/Channeltron electron multiplier detector
- ▶ minimum detectable partial pressure of 5×10^{-14} mbar
- ▶ maximum operating pressure of 1×10^{-4} mbar
- ▶ radiation hard with remote RF version

qRGA for Fusion Research

At nuclear fusion research facilities, spectral analysis of the vacuum conditions within Tokamaks is challenging due to complex interactions of hydrogen isotopes within the Tokamak. Typically, gas purity is assessed by using RGAs and obtaining a conventional mass spectrum. Validation of fusion fuel purity is complicated due to D_2 and 4He occupying the same atomic mass, 4 amu (mass separation 0.0254 amu), rendering fuel validation purity problematic using conventional mass spectrometry RGA techniques.

The qRGA provides a solution to this problem as it can also operate in a mode allowing complete control of the energy of the electrons emitted within the ionisation source, resulting in each species having a unique fingerprint that can be determined by qRGA. This mode of operation is known as Threshold Ionisation Mass Spectrometry (TIMS).



qRGA

FEATURES:

- ▶ real-time quantitative gas analysis in a mass range qRGA 1-200 amu
- ▶ sub PPM detection levels
- ▶ qRGA operates in both conventional mass analysis and TIMS modes
- ▶ 0.5 eV electron energy resolution over the range 0-150 eV
- ▶ low cost multi-unit solution with radiation and magnetic shielding solutions

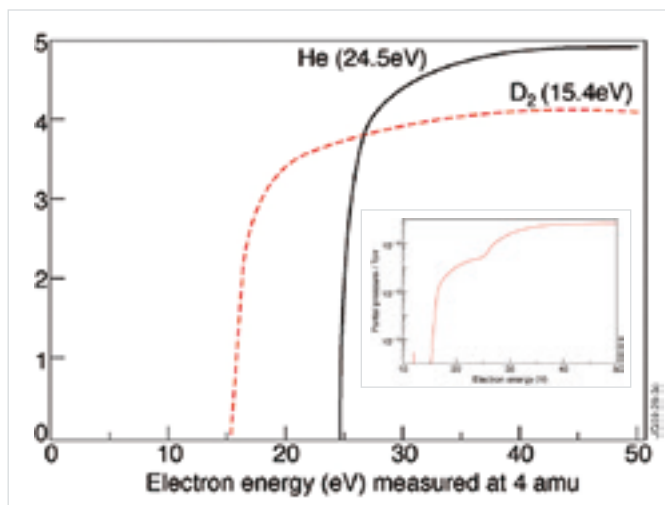

qRGA, real-time TIMS data taken at JET, UK. D_2 and 4He (with threshold ionisation energies at 15.4 eV and 24.5 eV respectively) are easily separated and quantifiable.

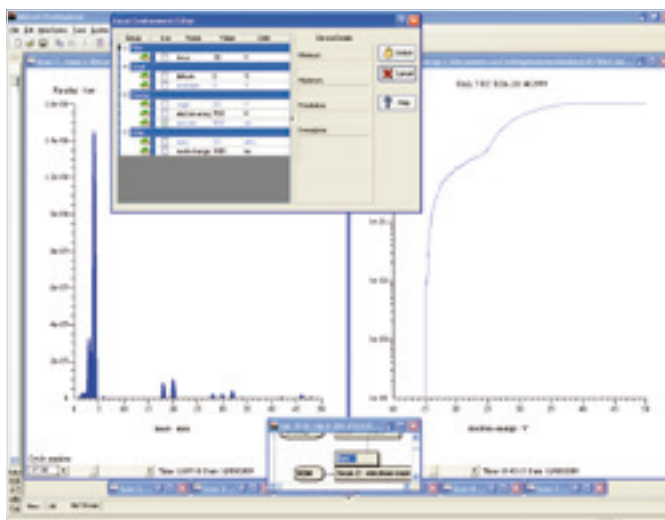

qRGA, real-time TIMS data taken at JET, UK. Spectra show scans at 3 amu, separating 3He from HD. Mass separation of 3He and HD: 0.0058 amu (difficult for any mass spectrometer to resolve in conventional mass mode), is a routine measurement for qRGA.

HALO 201 MBE

for Molecular Beam Epitaxy Applications

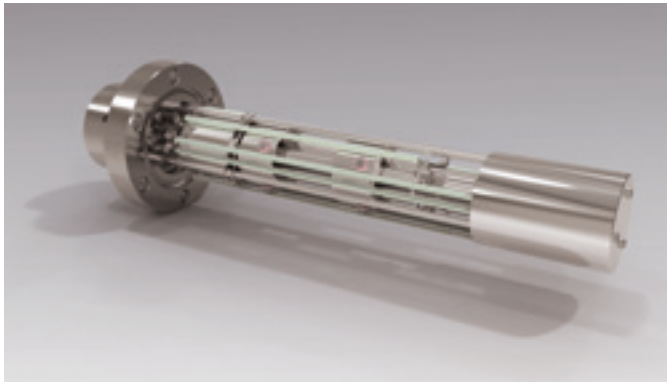

HALO 201 MBE analyser

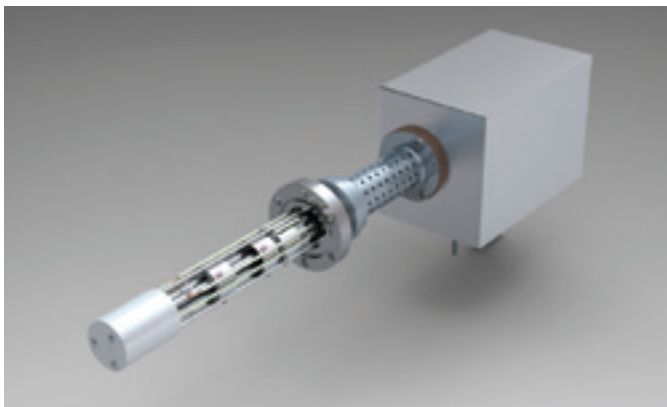

HALO 201 MBE with thermal extender option

The Hiden HALO systems are designed for RGA, gas analysis and process monitoring applications including leak detection, trend analysis and vacuum survey.

The MBE specific analyser is constructed from compatible materials and designed for prolonged use in MBE environments and includes, as standard, molybdenum wiring in place of copper and a contamination resistant ion source shroud.

- ▶ semiconductor
- ▶ oxides
- ▶ nitrides
- ▶ solar cells

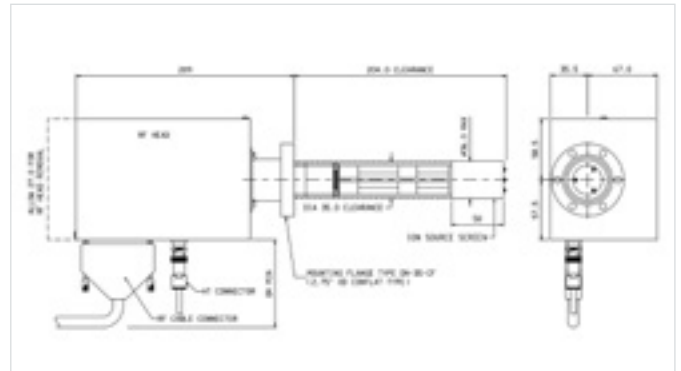

HALO 201 MBE analyser and RF head

FEATURES/OPTIONS:

- ▶ molybdenum wiring in place of copper wiring to improve RGA system lifetime in MBE environments
- ▶ contamination resistant ion source shroud
- ▶ dual Faraday/Channelplate electron multiplier
- ▶ minimum detectable partial pressure of 1×10^{-11} mbar (Faraday) and 2×10^{-13} mbar (Channelplate)
- ▶ thermal extender option for RGA operation during bakeout

XBS

Deposition Rate Monitor for Molecular Beam Analysis & Deposition Control

The Hiden XBS system is a quadrupole mass spectrometer designed for monitoring multiple beam sources simultaneously and uniquely offers beam acceptance through a 70° cone. Species-specific analogue signals are used for beam intensity output to the users' source control modules.

Beam acceptance apertures are configured individually for each specific process chamber source position, manufactured as replaceable plug-in elements to enable retrospective modification in event of chamber alteration. Purpose-designed with high contamination resistance for monitoring evaporating components and fragments in MBE processes. Manufactured with a triple stage mass filter and water-cooled fully-shrouded probe to protect the probe from the radiant heat sources and to inhibit probe contamination.

- ▶ **monitor and control in MBE processes**
- ▶ **molecular beam studies**
- ▶ **multiple beam source analysis**
- ▶ **photoionisation studies**
- ▶ **desorption/outgassing studies**
- ▶ **monitoring and diagnostics of contaminants in the process chamber**
- ▶ **high performance RGA with 3F series triple-stage mass filter**
- ▶ **high-sensitivity helium leak check mode for vacuum quality verification**

FEATURES:

- ▶ high sensitivity - minimum detectable partial pressure 2.5×10^{-14} mbar
- ▶ mass range: 320 or 510 amu
- ▶ crossbeam ion source, beam acceptance through +/- 35° to transverse axis
- ▶ beam acceptance apertures configured for beam source positions
- ▶ growth rate determination typically $< 0.01 \text{ \AA s}^{-1}$ (species dependent)
- ▶ optional water-cooled shroud



XBS probe

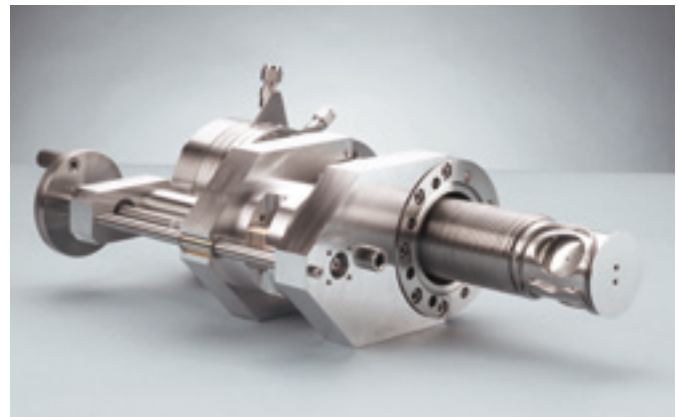

XBS probe with water-cooled shroud and Z-drive

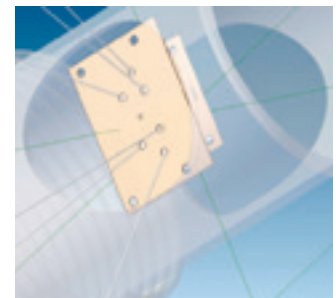

3F PIC

for UHV TPD

Hidden's 3F PIC Series quadrupoles are high precision triple filter analysers with digital detectors for ultimate sensitivity and time resolution in fast event studies such as UHV TPD. 3F PIC Series analysers are available with UHV compatible mass filter shrouds and low profile ion source for close positioning to the desorption surface.

Application specific software enables the user to control temperature ramp profiles and collect data in the same program (TPDsoft) or to simply collect MS data and temperature in the same program (EGAssoft).

Both analogue and digital inputs are provided for synchronous acquisition start and sample temperature data display alongside mass channel data.

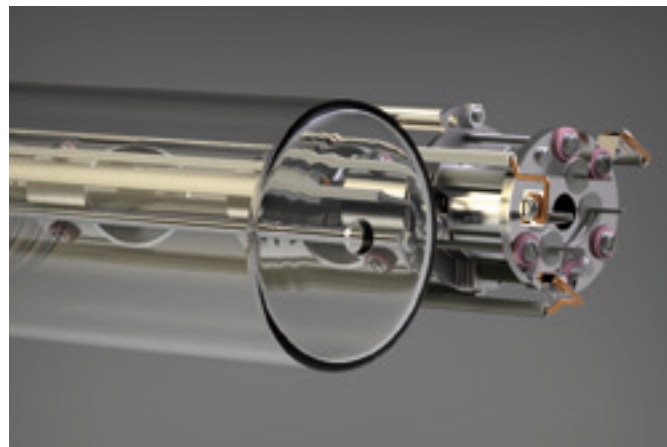

HAL 3F PIC and quartz shroud

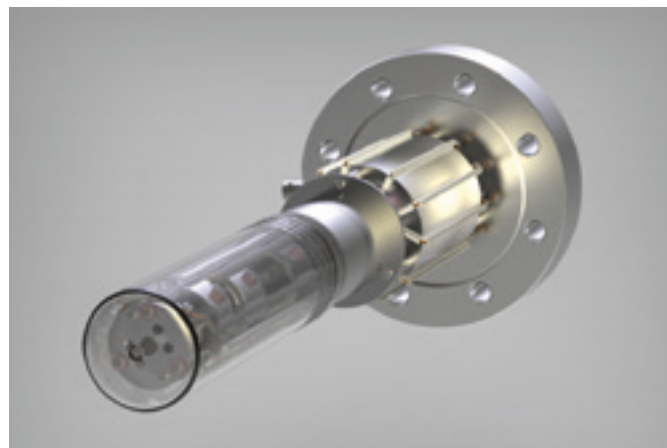

3F PIC with quartz shroud

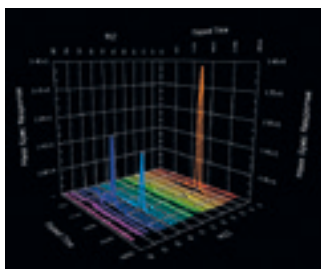

3D bar data view in TPDsoft.

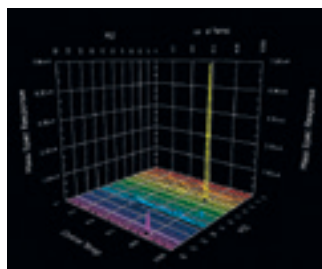

Display MS response vs. temperature.

FEATURES:

- ▶ low profile ion source
- ▶ range of shrouds
- ▶ fast data acquisition
- ▶ 650 data points per second
- ▶ wide dynamic range
- ▶ MCS mode option for time resolution to 50 ns
- ▶ 7 decade continuous log scale
- ▶ gating input for pulsed gas studies down to 100 ns gating resolution

EPIC & IDP

for UHV Analysis of Neutrals, Radicals & Ions

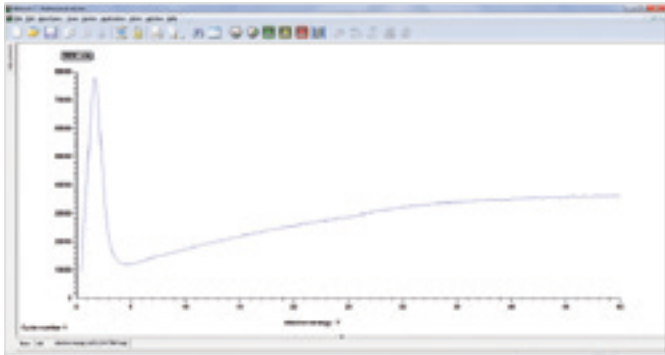

O⁻ ions formed by dissociative electron attachment $e + N_2O \rightarrow N_2^+ O^-$.

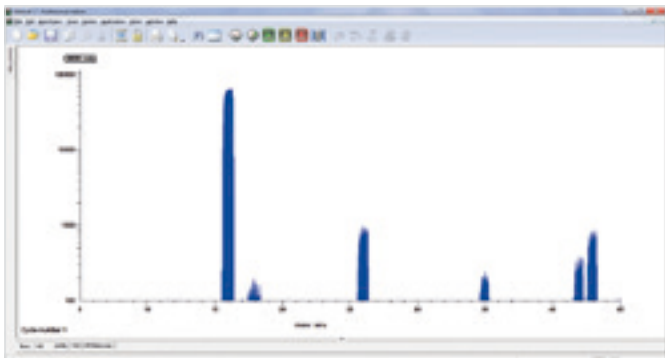

Mass spectrum of negative ions formed by low energy electron attachment.

The Hiden EPIC and IDP have all the features of high performance RGAs - but with the addition of pole bias mid-axis potential and negative ion capability making them outstanding research grade mass spectrometers.

The EPIC system is factory-upgradeable for inclusion of an energy filter, either the Bessel box or Hiden 45° sector field type, ensuring compatibility with the Hiden plasma/SIMS series including the EQP, EQS, PSM and SIM probes.

The Hiden IDP is for the direct analysis of low energy ions and neutrals from UHV surface science techniques. Applications include electron stimulated desorption, photon stimulated desorption and thermal desorption studies.

- ▶ UHV surface science
- ▶ electron stimulated desorption
- ▶ photon stimulated desorption
- ▶ thermal desorption studies
- ▶ radical analysis
- ▶ energy and biofuels
- ▶ time resolved studies

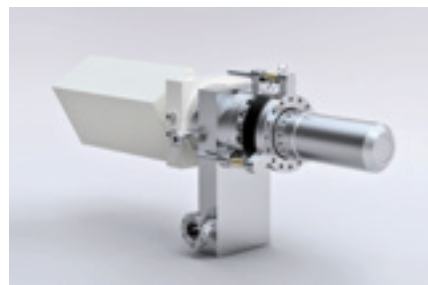

EPIC 1000 Series

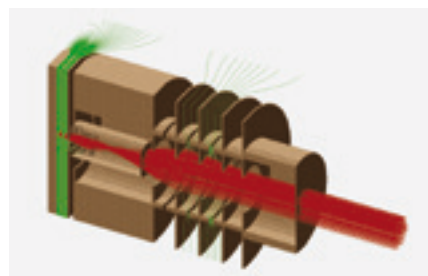

Simulation showing the focussing properties of IDP 4 lens ion optics.

EPIC FEATURES:

- ▶ pole bias mid-axis potential
- ▶ positive and negative ion detection
- ▶ Electron Attachment Mass Spectrometry (EAMS)

IDP FEATURES:

- ▶ pole bias mid-axis potential
- ▶ positive and negative ion detection
- ▶ Electron Attachment Mass Spectrometry (EAMS)
- ▶ 4 lens ion optics

3F SERIES 1000

for High Precision Scientific & Process Applications

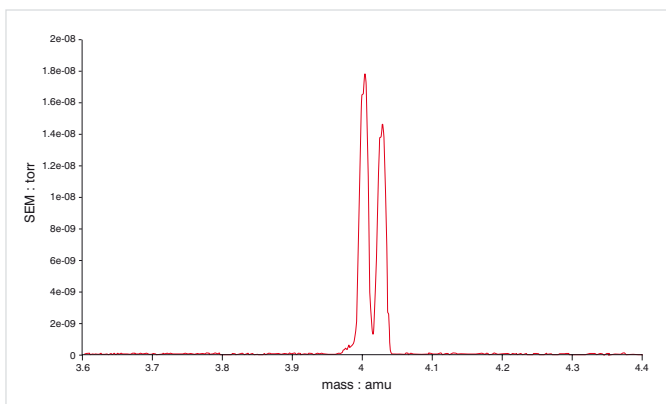

High mass resolution: HAL 1000 series 1-50 amu. Allows effortless separation of overlapping masses such as helium/deuterium at 4 amu (0.025 amu) in fusion research.

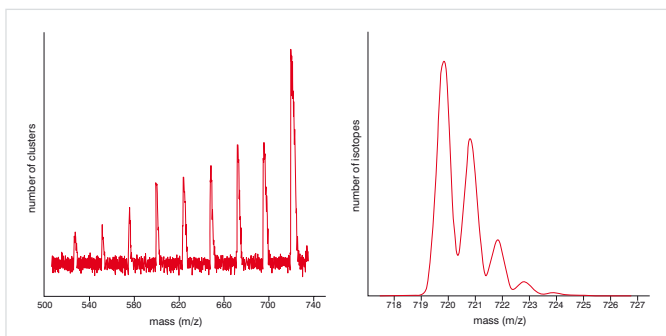

High mass transmission: Fullerene (C_{60}) vapour isotope fragment analysis.

The HAL 3F RC systems are designed for gas analysis in high precision scientific and process applications.

The triple filter quadrupole minimises contamination from unwanted ions, where pre and post filters operate at RF only. In combination with the longer primary mass filter and wider rod diameter of 9mm, this results in increased: mass resolution, ion sensitivity, stability for precision/ratio measurements and high mass transmission.



HAL 3F 1000

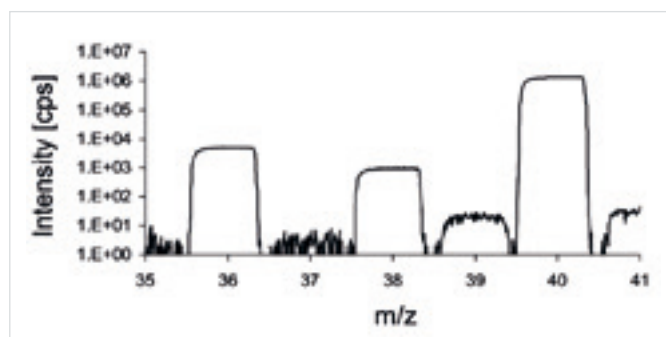

High stability for precision isotope ratio measurements: $^{40}\text{Ar}/^{39}\text{Ar}$ geochronology research[1].

FEATURES:

- ▶ mass range 1000/2500 amu, 9mm molybdenum rod design
- ▶ increased mass resolution, high mass transmission and ion stability
- ▶ full electron energy control 0-150 eV for complementary TIMS analysis mode
- ▶ available with SEM or PIC detection or optional dual Faraday/SEM or Faraday/PIC models

HAL 1000 series 9mm: Researchers[1] concluded that the Hiden system outperformed their expectations, and is comparable to the magnetic sector instrument they routinely use in this field of research.

They measured the precision ratio of the $^{40}\text{Ar}/^{39}\text{Ar}$ isotopes over a two year period and concluded:

"Over two years the position of the flat peak centre did not move significantly even after maintenance events. For $a^{40}\text{Ar}$ beam size of 1×10^6 cps, peak width is 0.9 amu at 10 cps and 0.84 amu at 5×10^5 cps, clearly separating it from neighbouring masses. The stability of the Hiden QMS compares favourably to the MAP215-50. Air standard $^{40}\text{Ar}/^{36}\text{Ar}$ of the Hiden QMS 257.9 ± 1.3 ($n=34$ since July 2006) compares to 293.1 ± 3.3 ($n=739$) measured with the magnetic sector mass spectrometer instrument since the beginning of 2007."[1]

[1] Björn Schneider et al. 2009 Quaternary Geochronology 4 Pages 508-516

RGa CONTROL SOFTWARE

MASsoft, *netMASsoft*, Advanced Software Features

All Hiden Residual Gas Analysers are supplied with MASsoft mass spectrometer PC control software and *netMASsoft*.

MASsoft Professional software is intuitive and multi-level offering simple operation for a novice user whilst incorporating a broad range of useful and advanced features for the vacuum expert.

netMASsoft - a Java application for RGA operation directly from within your web browser.

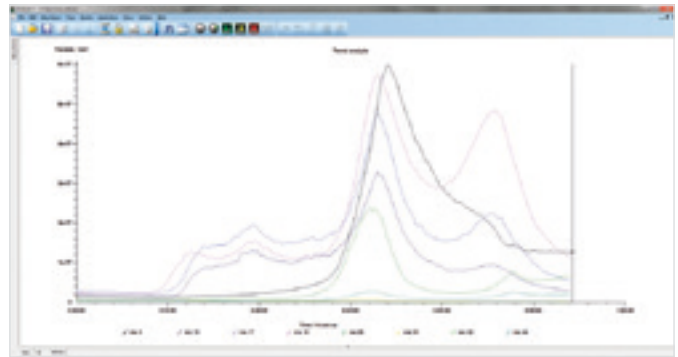

Trend analysis



netMASsoft - a Java application for RGA operation directly from within your web browser.



Scan gallery - scan selector mode

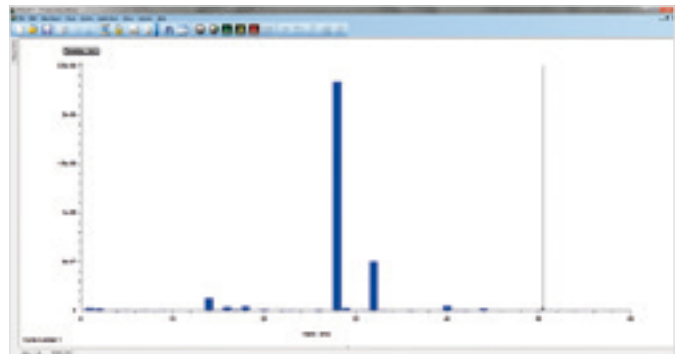

Mass scan - histogram

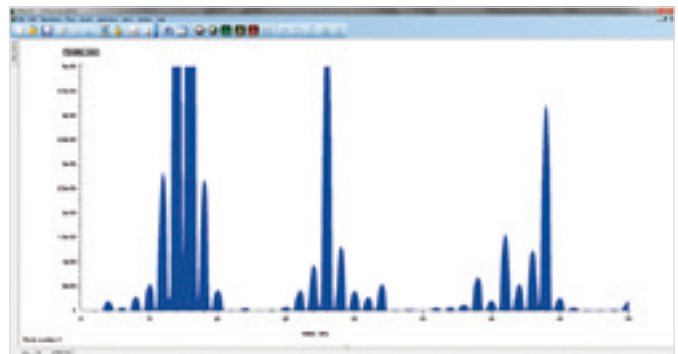

Mass scan - profile

SOFTWARE FEATURES:

- ▶ template driven quick start operation
- ▶ multiple RGA operation over ethernet link
- ▶ real-time data display with zoom feature
- ▶ mixed mode scanning including trend analysis view of selected species from broad mass scans
- ▶ statistical analysis and peak integration
- ▶ accessible data with copy/paste functions and automated data export
- ▶ auto mass alignment
- ▶ integrated mass spectral library

RGa CONTROL SOFTWARE

Advanced Software Features

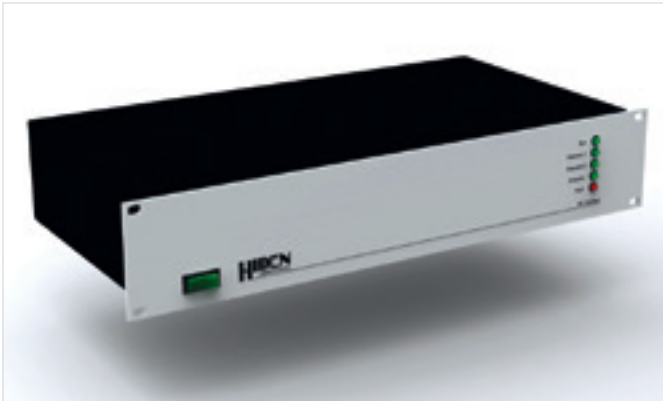

RC RGA interface

MASsoft Professional PC software provides for mass spectrometer data acquisition and control, providing a user friendly interface for the acquisition of mass spectrometer data. Behind the simplicity of the point and click automatic scan gallery are layers of flexibility allowing users to acquire, store and present mass spectrometer data in formats directly suited to their application.

- ▶ background subtract - for real-time comparison of vacuum quality
- ▶ extract trend analysis for any mass peak(s) within the scan
- ▶ 4, 6 or 8 decade high dynamic range scan modes
- ▶ derived data values for data presentation in % or PPM for example

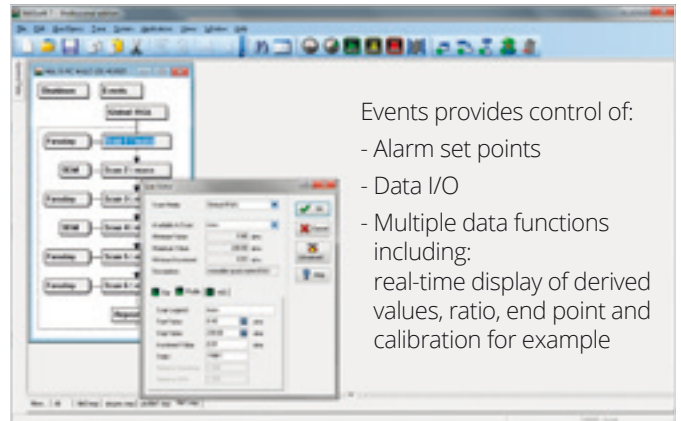

Events provides control of:

- Alarm set points
- Data I/O
- Multiple data functions including:
real-time display of derived values, ratio, end point and calibration for example

MASsoft control - fully editable scan sequence with selectable: scan mode, detector and mass spectrometer parameters set individually for each scan in the sequence.

RGa MASS SPECTROMETER INTERFACE INCLUDES:

- ▶ ethernet TCP/IP, USB and RS232 communication links
- ▶ I/O subsystem with: multi-protocol RS485 links for external devices, mass flow controllers, CO analyser, total pressure gauges for example
- ▶ 5 channel TTL for process control/automatic start - stop trigger
- ▶ analogue data input and output options

Hidden **APPLICATIONS**

Hidden's quadrupole mass spectrometer systems address a broad application range in:

GAS ANALYSIS

- ▶ dynamic measurement of reaction gas streams
- ▶ catalysis and thermal analysis
- ▶ molecular beam studies
- ▶ dissolved species probes
- ▶ fermentation, environmental and ecological studies



SURFACE ANALYSIS

- ▶ UHV TPD
- ▶ SIMS
- ▶ end point detection in ion beam etch
- ▶ elemental imaging – 3D mapping

HIDDEN

ANALYTICAL

Hidden Analytical Ltd.
420 Europa Boulevard
Warrington WA5 7UN England

T +44 [0] 1925 445 225
F +44 [0] 1925 416 518
E info@hidden.co.uk
W www.HiddenAnalytical.com



Sales Offices:

We have sales offices situated around the globe. **Visit our website for further information.**



PLASMA DIAGNOSTICS

- ▶ plasma source characterisation
- ▶ etch and deposition process reaction kinetic studies
- ▶ analysis of neutral and radical species



VACUUM ANALYSIS

- ▶ partial pressure measurement and control of process gases
- ▶ reactive sputter process control
- ▶ vacuum diagnostics
- ▶ vacuum coating process monitoring

